

 MADE IN GERMANY

Moonlight

TECHNOLOGY



2024
Peace of mind

Moonlight - the Original

In today's globally networked world, companies more than ever have to deal with new and constantly changing markets. Social change and technical innovations influence the way we live and how we communicate with each other.

On the other hand, the basic needs of us have remained the same: we want to feel at home, safe and connected to our closest fellows.

Ever since we've been relaxing around the campfire from hunting trips, the role of the light for us has remained essentially the same. Today, smart lamps that we control with apps create a cozy home where we meet, spend time together and participate in each other's lives.





And Moonlight is right in the middle.



That is why we are convinced: „Moonlight makes you happy.“

Bartolomeo Caputo,
CEO of Moonlight Technology AG

What makes a genuine Moonlight so unique?

-  **Moonlight lights were the first ball lights on the market, that spread shadow-free illumination and an uniquely soft light**
-  **To date, Moonlight has the greatest material strength of all comparable products, resulting in a long lasting life and incredible robustness**
-  **We offer more base variants and mounting options than comparable products, which opens up almost unlimited possibilities when designing with light**
-  **Moonlight has won numerous design awards**
-  **Over 20 years of experience and „proudly“ made in black forest**

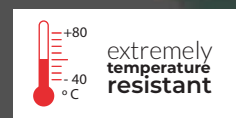



The Elegance and Beauty of German Lights

From ambient to bright, explore how current technology has transformed the concept of design. A showcase of modern and timeless designs to create a sustainable future and seamless integration.

On the 25th anniversary of its foundation, Moonlight Technology will participate in the Light Building MEA conference, which will be held at Dubai World Trade Center for three consecutive days beginning on January 17 and concluding on January 19, 2023. The event will also be celebrating the successful expansion of Moonlight Technology, which started in Germany and now has made its way to the Middle East.

Moonlight Technology prides its production in Germany, which they will be exhibiting at the conference. They are proven to be economically friendly that can save up to 80% of cost compared to other manufacturers. German light products have led the market for years with their efficiency, durability, and sleek designs.

The Light Building MEA will hold its 16th edition this year, they are widely known as the region's premier exhibition, conference, awards for lighting, design, and building technology. The conference will bring local lighting professionals and manufacturers from different parts of the world to discuss current innovations and new technologies needed to cater to the expanding innovation and lighting markets.

Over the years, Moonlight Technology has won numerous design awards and has maintained its high reputation by preserving its social and environmental responsibilities through its extended production and durability.

Light enthusiasts, suppliers, and interested visitors are welcome to join and be part of the upcoming exhibition by registering for a free pass through the official Light Middle East website. Moonlight Technology also invites people for their celebration and the presentation of their award-winning luminaires while also being able to experience first-hand high-class interior and exterior lighting and a nuanced atmosphere valued by architects and designers worldwide.



17- 19 January 2023
Dubai World Trade Centre

Moonlight - one sphere - many possibilities

Hardly any outdoor light is as versatile as the Original Moonlight!
Moonlight lights can be adapted to any needs by choosing the ideal socket and light source.

Surface Base MAG/HMAG



Ideal for

- Ways
- Terraces
- Balcony & Courtyard
- Stairways
- Floor
- Wall
- Close to water
as low voltage version

Sub-Surface Base MBG/HMBG



Ideal for

- Gardens
- Ways
- Soil
- Gravel Surfaces

Portable Base MFL/HMFL









Ideal for

- Terrace
- Courtyard & Balcony
- Living Area
- Inside, Outside &
Wet rooms

Floating Base MWL/MWB







Ideal for

-  Lakes
-  Ponds
-  Pools
-  Seawater
-  With 12 V
-  Optionally with battery

Battery Base MFB/MWB







Ideal for

-  Home & Garden
-  Gastronomy
-  Events & events
-  Camping & Outdoors
-  Optionally also as floating light

Sound Base MFLS/MFLAS



Ideal for

-  Inside Outside
-  Gastronomy
-  Events & Festivals
-  Hotels & Leisure Parks



Pendant Base MPL/F

-  Inside & Outside Ceiling

Moonlight installed on a solid surface

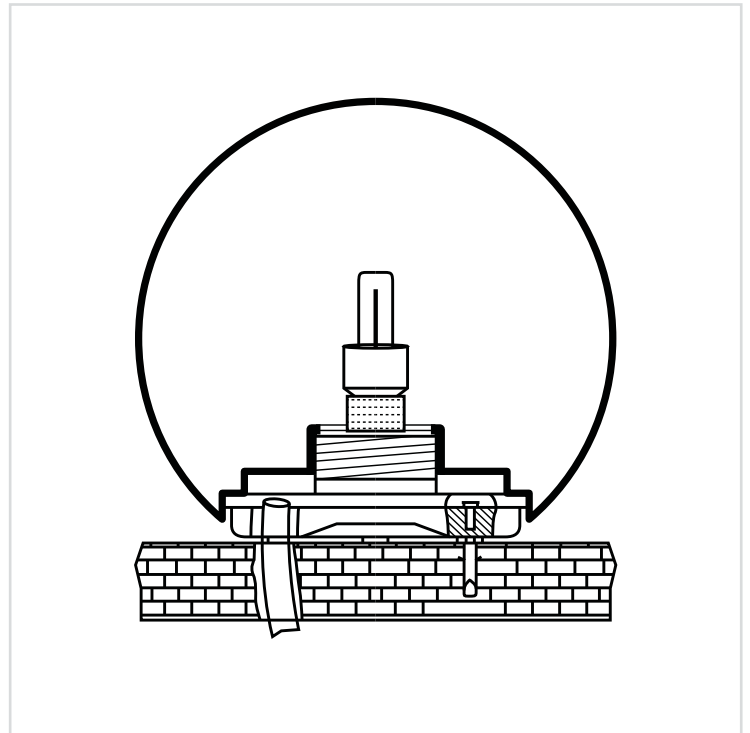

Moonlight with Surface Base [MAG]

Floor or wall lamp for a fixed and permanent installation to the ground

This Moonlight is firmly screwed to the surface or the wall. It can be used both inside and outside and immerses its surroundings in the characteristic soft Moonlight light.

Luminaires with a screw-on base are supplied without a cable, which can be permanently laid, installed safely and permanently on site by your electrician.

Highlights & product variants

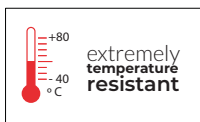

Size 25 cm, white
Art-No MAG-2500
EAN Code 4055058020209

Size 35 cm, white
Art-No MAG-3500
EAN Code 4055058030208

Size 55 cm, white
Art-No MAG-5500
EAN Code 4055058050206

Size 75 cm, white
Art-No MAG-7500
EAN Code 4055058070204

Opt. Colors granite light, granite dark, sandstone

Cable not included

Cable Length opt. 5 m, 10 m, 20 m

Socket E26/E27

Nominal Voltage 110 V/230 V

Protection IP 66

Protection Class II



Half Moonlight installed on a solid surface

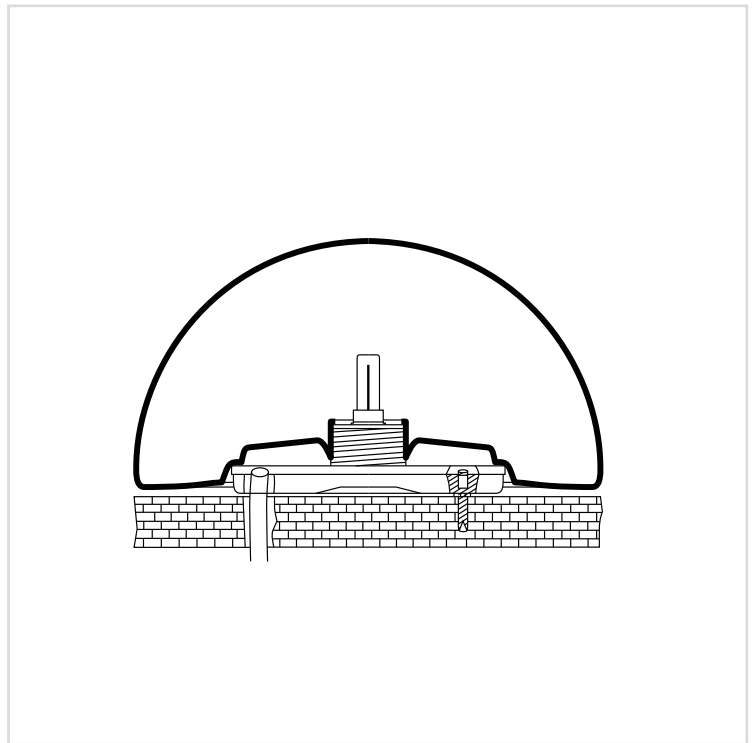

Hemisphere Globe Surface Base [HMAG]

Hemispherical globe for a fixed and permanent installation to the ground

This Moonlight lamp is firmly screwed to the surface or the wall. It can be used both inside and outside and immerses its surroundings in the characteristic soft Moonlight light.

Luminaires with a screw-on base are supplied without a cable, which can be permanently installed by your local electrician.

Highlights & Product Variants

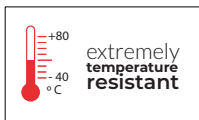

Size 35 cm, white
Art-No HMAG-3500
EAN Code 4055058040207

Size 55 cm, white
Art-No HMAG-5500
EAN Code 4055058060205

Size 75 cm, white
Art-No HMAG-7500
EAN Code 4055058080203

Opt. Colors granite light, granite dark, sandstone

Cable not included
Cable Length opt. 5 m, 10 m, 20 m

Socket E26/E27

Nominal Voltage 110 V/230 V

Protection IP 66

Protection Class II



Moonlight & Smart LED

Moonlight Luminaires with LED RGB Lamps can easily be connected with your Smarthome. Use smart bulbs and enjoy the following benefits:



Set the mood in your home

With smart bulbs you can quickly and easily control your lights or choose your scenarios. You can automatically control all intelligent lights in a room via the app or a remote control.

Lightning fast, wireless control

Steplessly dim your light and adjust the brightness to your needs, depending on whether you want to work, read or relax.

Play with the colors

Modern RGB light sources can change the light color in almost any way. With a choice of 16 million colors, you can immerse a room in a suitable ambient light and give your home a special touch or emit a work-friendly glow.



Control with smartphone apps or with the manufacturer's remote control

A large number of apps are available for smartphones that enable lamp groups or entire rooms to be controlled.

Different scenarios can be saved and recalled later, controlled with a timer or externally.

Whichever lighting system you choose – expand the functionality of a moonlight with smart LED lamps!



We recommend smart bulbs with the zigbee standard for our Moonlight lights. Look for this logo when purchasing or order them on <https://moonlight24.eu>



Timeless design and well thought out down to the last detail: Instead of an intermediate pedal switch, we installed a discreet touch sensor.

New to Moonlight

Moonlight Indoor with knock sensor

We are proud to present our indoor moonlight with cotton-covered cable. Thanks to the built-in touch sensor, this light does not need an external switch and can be switched on and off simply by touching. Of course, you can also use smart bulbs and thus integrate the stylish lamp into your smart home.

Moonlight anchored in the soft ground

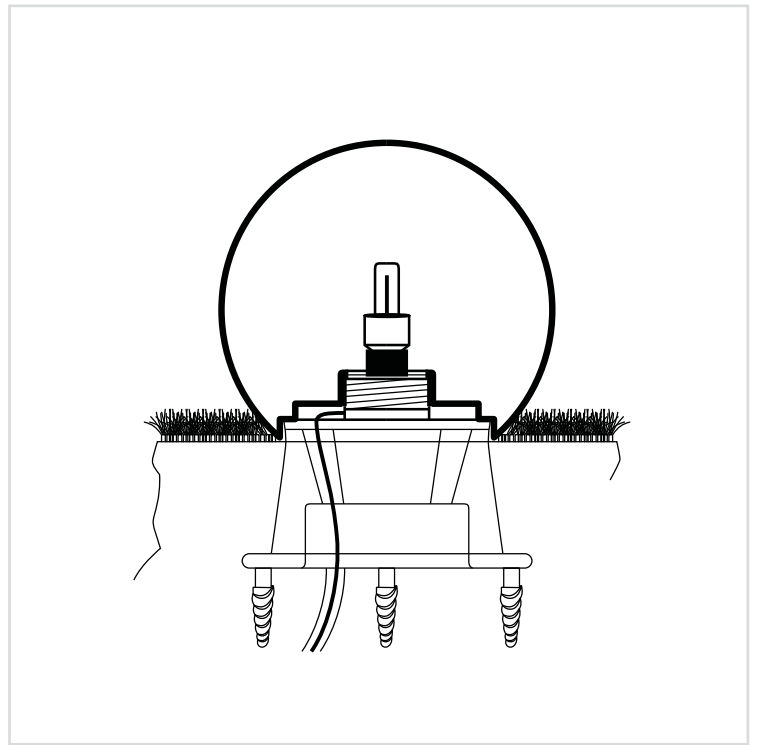

Moonlight with Sub-Surface Base [MBG]

Moonlight luminaire for permanent under-ground installation.

Installation with an under ground base requires laying the cable in the ground (not included in the scope of delivery).

Ground dowels can be used on less solid ground and to secure against twisting.

Highlights & Product Variants

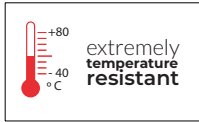

Size 25 cm, white
Art-No MBG-2500
EAN Code 4055058020407

Size 35 cm, white
Art-No MBG-3500
EAN Code 4055058040405

Size 55 cm, white
Art-No MBG-5500
EAN Code 4055058060403

Size 75 cm, white
Art-No MBG-7500
EAN Code 4055058080401

Opt. Colors granite light, granite dark, sandstone

Cable not included

Cable Length opt. 5 m, 10 m, 20 m

Socket E26/E27

Nominal Voltage 110 V/230 V

Protection IP 66

Protection Class II



Moonlight anchored in the soft ground

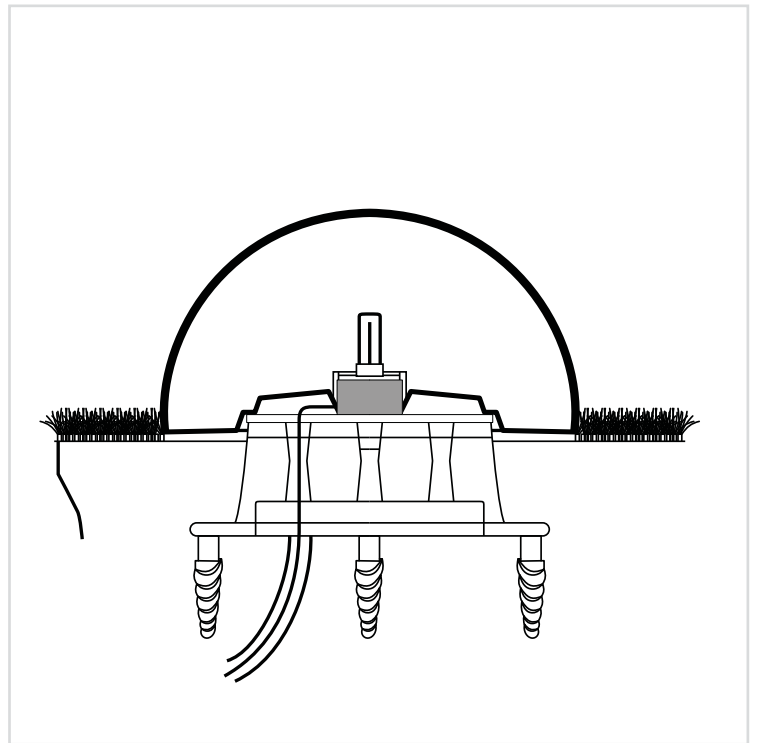
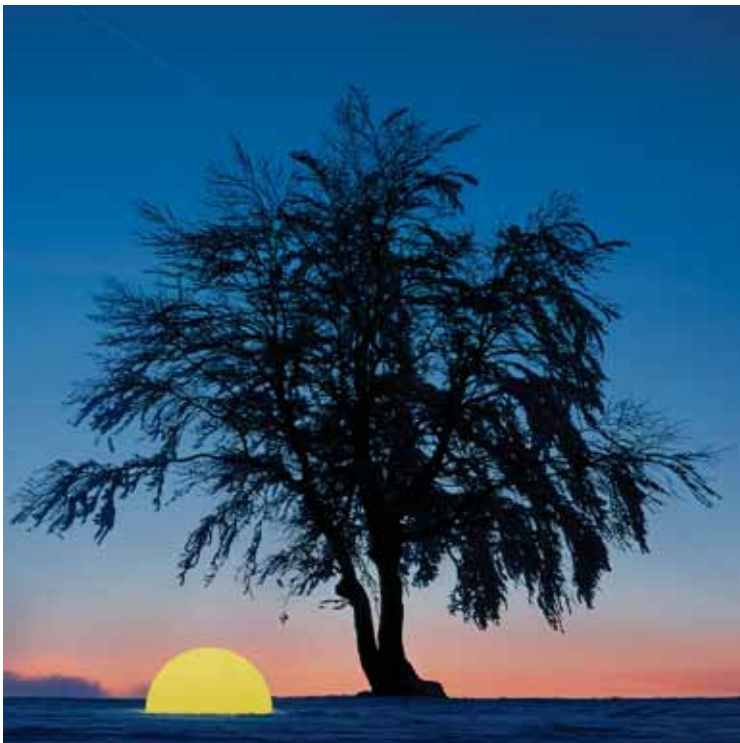

Hemisphere Globe + Sub-Surface Base [HMBG]

Moonlight luminaire for permanent underground installation.

Installation with an under ground base requires laying the cable in the ground (not included in the scope of delivery).

Ground dowels can be used on less solid ground and to secure against twisting.

Highlights & Product Variants

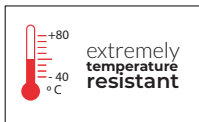

Size 35 cm, white
Art-No HMBG-3500
EAN Code 4055058040405

Size 55 cm, white
Art-No HMBG-5500
EAN Code 4055058060403

Size 75 cm, white
Art-No HMBG-7500
EAN Code 4055058080401

Opt. Colors granite light, granite dark, sandstone

Cable not included

Cable Length opt. 5 m, 10 m, 20 m

Socket E26/E27

Nominal Voltage 110 V/230 V

Protection IP 66

Protection Class II



Mobile & flexible Moonlight

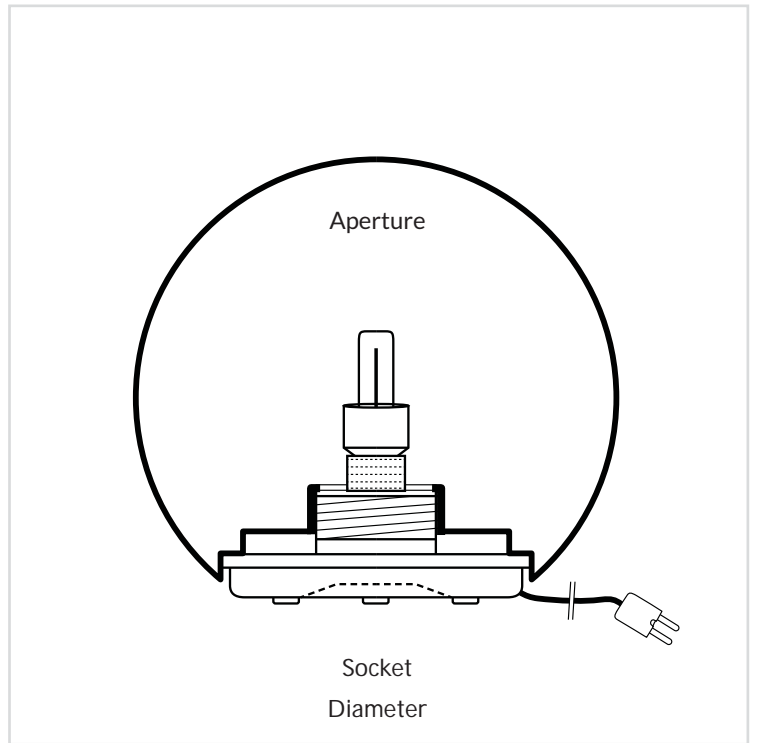

Moonlight Flexible Base [MFL]

Perfect for patio, yard and living area.

The Moonlight with a flexible base can be placed anywhere you like. It is supplied with a built-in cable of 5 m length, other cable lengths are optionally available.

The flexible lamp can be used indoors and outdoors as well as in damp rooms - wherever a subtle light and atmospheric mood is desired.

Highlights & Product Variants

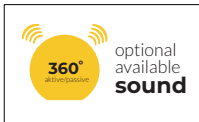
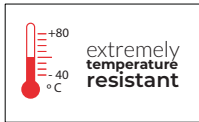

Size 25 cm, white
Art-No MFL-2500
EAN Code 4055058020001

Size 35 cm, white
Art-No MFL-3500
EAN Code 4055058030000

Size 55 cm, white
Art-No MFL-5500
EAN Code 4055058050008

Size 75 cm, white
Art-No MFL-7500
EAN Code 4055058070006

Opt. Colors granite light, granite dark, sandstone

Cable Length 5 m

Cable Length opt. 10 m, 20 m

Socket E26/E27

Nominal Voltage 110 V/230 V

Protection IP 66

Protection Class II



Mobile & portable Moonlight with Battery

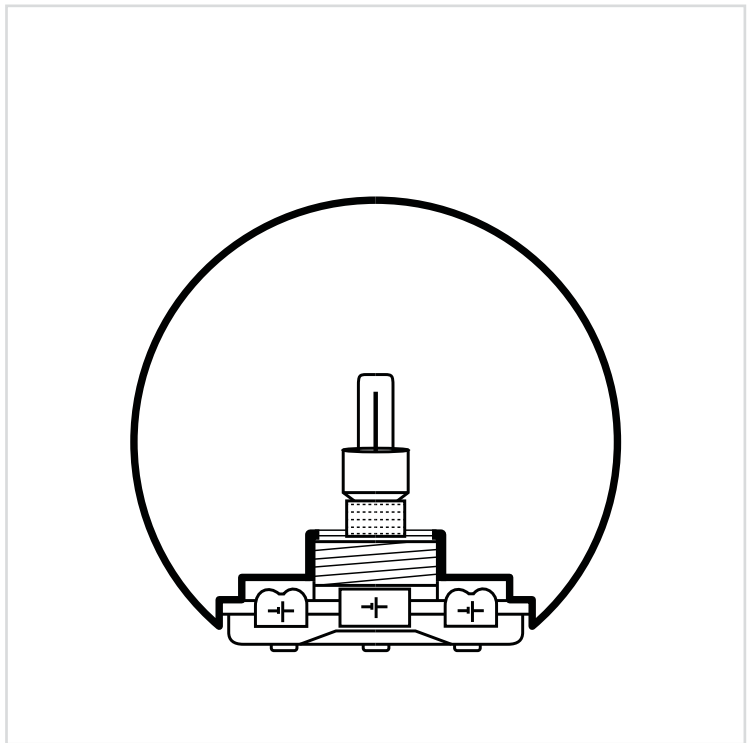

Moonlight Battery Base [MFB]

Perfect for on the go, parties, events and your camping site.

The Moonlight with rechargeable battery and flexible base can be placed anywhere you like. The rechargeable batteries make them mobile and can be used anywhere.

The battery-powered light can be used indoors and outdoors as well as in damp rooms - wherever a subtle light and atmospheric mood is desired.

Highlights & Product Variants

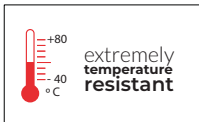

Size 25 cm, white
Art-No MFB-2500
EAN Code 4055058021602

Size 35 cm, white
Art-No MFB-3500
EAN Code 4055058031601

Size 55 cm, white
Art-No MFB-5500
EAN Code 4055058051609

Size 75 cm, white
Art-No MFB-7500
EAN Code 4055058071607

Opt. Colors granite light, granite dark, sandstone

Socket E26/E27

Nominal Voltage 12 V

Protection IP 66

Protection Class II



Moonlight „on air“

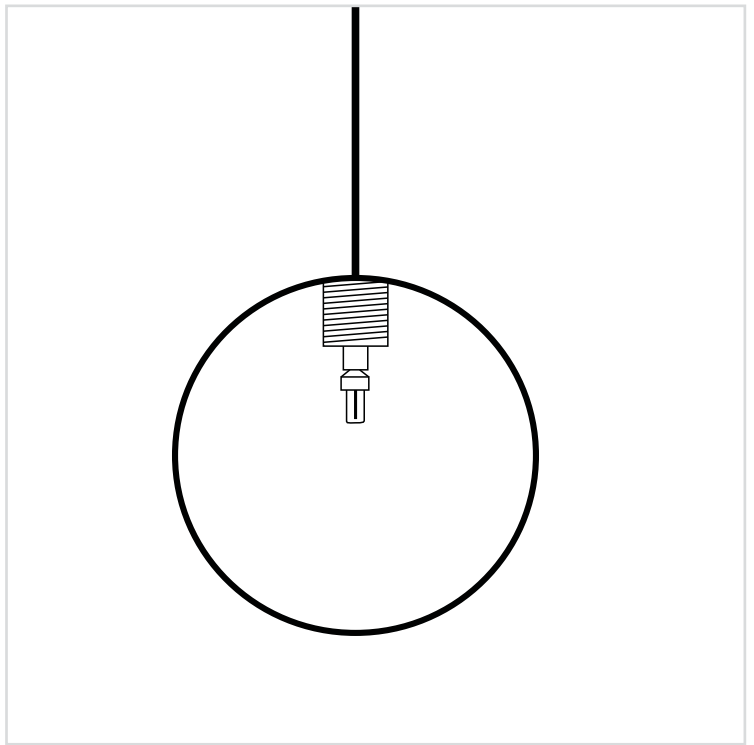

Moonlight Pendant Light [MPL/F]

Pendant lights and tension lights open up completely new possibilities for lighting design in indoor and outdoor areas and enrich modern and classic architecture.

The standard cable with integrated steel cable has a minimum breaking strength of approx. 3700 kN.

Highlights & Product Variants

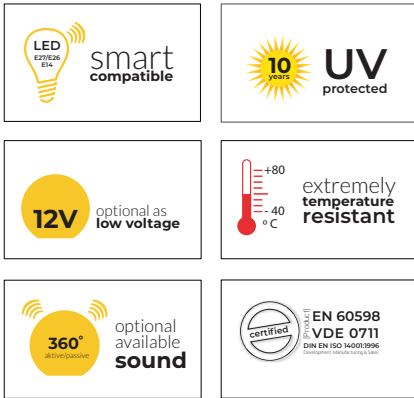

Size 35 cm, white
Art-No MPL-3500
EAN Code 4055058030604
Art-No MPLF-3500
EAN Code 4055058130809

Size 55 cm, white
Art-No MPL-5500
EAN Code 4055058050602
Art-No MPLF-5500
EAN Code 4055058150807

Size 75 cm, white
Art-No MPL-7500
EAN Code 4055058070600
Art-No MPLF-7500
EAN Code 4055058170805

Opt. Colors granite light, granite dark, sandstone

Cable Length 3 m
Socket E26/E27
Nominal Voltage 110 V/230 V
Protection IP 66
Protection Class II



Moonlight "on air"

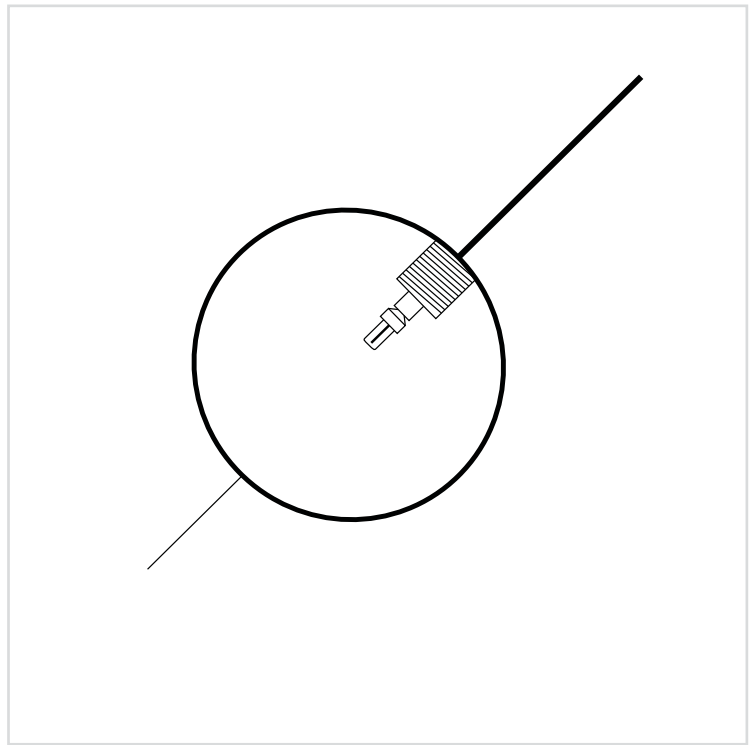

Moonlight Pendant Light [MPL/F]

Pendant lights and tension lights open up completely new possibilities for lighting design in indoor and outdoor areas and enrich modern and classic architecture.

The standard cable with integrated steel cable has a minimum breaking strength of approx. 3700 kN.

Highlights & Product Variants

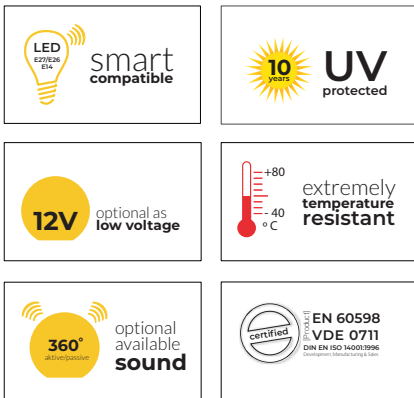

Size 35 cm, white
Art-No MPL-3500
EAN Code 4055058030604
Art-No MPLF-3500
EAN Code 4055058130809

Size 55 cm, white
Art-No MPL-5500
EAN Code 4055058050602
Art-No MPLF-5500
EAN Code 4055058150807

Size 75 cm, white
Art-No MPL-7500
EAN Code 4055058070600
Art-No MPLF-7500
EAN Code 4055058170805

Opt. Colors granite light, granite dark, sandstone

Cable Length 3 m
Socket E26/E27
Nominal Voltage 110 V/230 V
Protection IP 66
Protection Class II



Moonlight in- & on the water

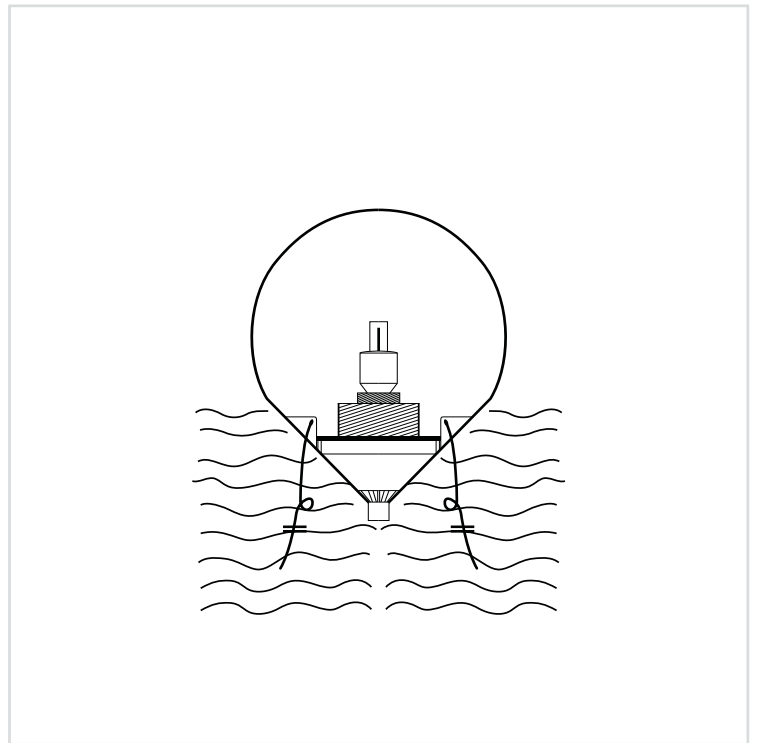

Lights that are installed at the edge of a pool must be operated with a voltage of 12 volts due to legal requirements. That's why we also offer our MAG model in a low voltage version.

Moonlight Floating Light [MWL]

Moonlights in- & on the water

Moonlight lighting also works near or in water and turns ponds, lakes or pools in a dreamlike light source.

Original Moonlight lights can also be used in damp rooms, near and even in water without any problems. A power supply with IP67 splash protection and 12V output voltage is used for this, which makes operation reliable and safe.

Floating lights are suitable for various purposes in lakes, pools, on yachts and even in sea water. Cable-operated floating lights are anchored to the bottom with a steel cable.

Size 25 cm, white
Art-No MWL-2500
EAN Code 4055058121005

Size 35 cm, white
Art-No MWL-3500
EAN Code 4055058131004

Size 55 cm, white
Art-No MWL-5500
EAN Code 4055058151002

Size 75 cm, white
Art-No MWL-7500
EAN Code 4055058171000

Highlights & Product Variants

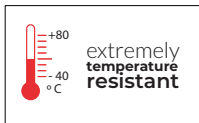
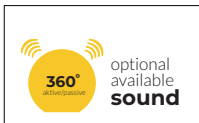

Cable Length opt. 10 m, 20 m
Socket E26/E27
Nominal Voltage 12 V
Protection IP 68
Protection Class II

Including power supply unit, 12V DC lamp and 6 m fastening line



Soft Light & Strong Sound

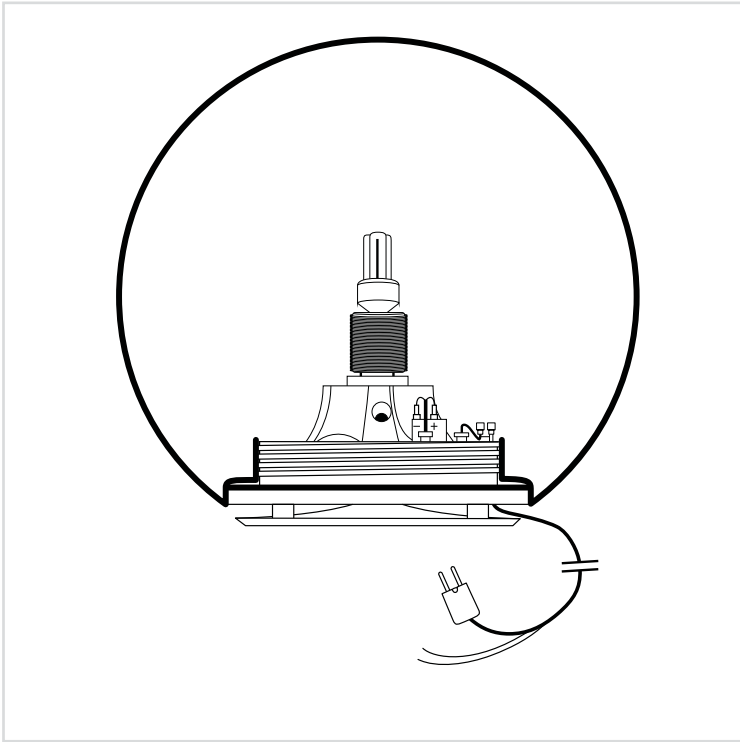

Moonlight Sound [MFLS/MFLAS]

Ambient light with sound

The Moonlight Sound models combine the uniquely soft Moonlight light with a subtle and rich sound. This makes it a practically invisible loudspeaker for the patio and garden, which can be controlled either with Bluetooth (active sound) or integrated into an existing room sound system (passive sound).

Since the Moonlight Sound, like all Moonlights, is UV and splash-proof, they are the first choice for the outside area of restaurants, or for hotel lobbies, reception and lounge areas.

Highlights & Product Variants

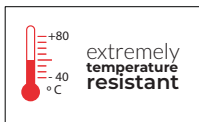

Size 35 cm, white
Art-No MFLS-3500 passive
EAN Code 4055058232008

Size 55 cm, white
Art-No MFLS-5500 passive
EAN Code 4055058252006
Art-No MFLAS-5500 active
EAN Code 4055058153006

Size 75 cm, white
Art-No MFLS-7500 passive
EAN Code 4055058272004

Opt. Colors granite light, granite dark, sandstone

Cable Length 5 m
Cable Length opt. 10 m, 20 m
Socket E26/E27
Nominal Voltage 110 V/230 V
Protection IP 66
Protection Class II



Cleaning & Care

The original Moonlight lights are made of high-quality polyethylene and have a very smooth surface. As a result, only a little dirt sticks to the polished material. Over time, rain and moisture can cause impurities from the air to settle on the light or moss to form.

Basically, the Moonlight lights are splash-proof, so they can simply be rinsed off with water - or even cleaned with a high-pressure cleaner. If that's not enough, we recommend wiping it down with a microfiber cloth. If necessary, some washing-up liquid can also be added to the wash water. Under no circumstances should a cleaning sponge with scouring fleece be used, as this scratches the surface and dirt can easily collect on it.



Learn more

Moonlight lights are extremely robust and require very little maintenance. So that you can enjoy your Moonlight for years to come, we have put together the most important questions and answers on this page.



Customized solutions

A strong branding plays an increasingly important role for many companies, the Corporate Identity should become an experience for the customer with every visit. Hardly any other lighting system is as timeless and universally adaptable to different needs and architectural styles as the original Moonlight lights.

Talk to us about a tailor-made lighting design that turns your corporate values into a recognizable and unique experience.



Technical Data

Model	Shape	Base	Dimensions		Colors
			Globe-Ø mm	Base-Ø mm	
MFL-2500	Full Globe	Portable Base	250	149	White, light granite, dark granite, sandstone, other colors on request, e.g. neverdark
MFL-3500	Full Globe	Portable Base	350	210	
MFL-5500	Full Globe	Portable Base	550	318	
MFL-7500	Full Globe	Portable Base	750	438	
HMFL-3500	Hemisphere Globe	Portable Base	350	250	
HMFL-5500	Hemisphere Globe	Portable Base	550	317	
HMFL-7500	Hemisphere Globe	Portable Base	750	438	
MAG-2500	Full Globe	Surface Base	250	149	
MAG-3500	Full Globe	Surface Base	350	210	
MAG-5500	Full Globe	Surface Base	550	318	
MAG-7500	Full Globe	Surface Base	750	438	
HMAG-3500	Hemisphere Globe	Surface Base	350	250	
HMAG-5500	Hemisphere Globe	Surface Base	550	317	
HMAG-7500	Hemisphere Globe	Surface Base	750	438	
MBG-2500	Full Globe	Sub-Surface Base	250	149 (o)/215(u)	
MBG-3500	Full Globe	Sub-Surface Base	350	210 (o)/300(u)	
MBG-5500	Full Globe	Sub-Surface Base	550	318(o)/466(u)	
MBG-7500	Full Globe	Sub-Surface Base	750	438(o)/636(u)	
HMBG-3500	Hemisphere Globe	Sub-Surface Base	350	250(o)/340(u)	
HMBG-5500	Hemisphere Globe	Sub-Surface Base	550	317(o)/466(u)	
HMBG-7500	Hemisphere Globe	Sub-Surface Base	750	438(o)/636(u)	
MWL-2500	Full Globe	Floating Base	250	110	
MWL-3500	Full Globe	Floating Base	350	110	
MWL-5500	Full Globe	Floating Base	550	210	
MWL-7500	Full Globe	Floating Base	750	210	
MPL/F-3500	Full Globe	Pendant Base	350	n.a.	
MPL/F-5500	Full Globe	Pendant Base	550	n.a.	
MPL/F-7500	Full Globe	Pendant Base	750	n.a.	

Contact

Moonlight Headquarter

Moonlight Technology AG
Lettenbündte 10
Germany – 79739 Schwörstadt

email@moonlight-technology.de
Phone: +49 (0) 77 62 – 709-0

Moonlight Middle East

Moonlight Technology DWC-LLC
Dubai Global Connect
Dubai South, UAE

bc@moonlight-technology.de
Phone: +49 171 208 4144
Mobile: +971 50 704 2490



MADE IN GERMANY

Features							
Socket	Voltage	Protection	Protection Class	Recommended lightsource output lm	UV Protection	Cable Length m	
E26/E26/E27	110 V/230 V	IP 66	II	300	10 Years	2, 5, 10	
E26/E26/E27	110 V/230 V	IP 66	II	500	10 Years	2, 5, 10	
E26/E26/E27	110 V/230 V	IP 66	II	800	10 Years	2, 5, 10	
E26/E26/E27	110 V/230 V	IP 66	II	1200	10 Years	2, 5, 10	
E26/E26/E27	110 V/230 V	IP 66	II	500	10 Years	2, 5, 10	
E26/E26/E27	110 V/230 V	IP 66	II	800	10 Years	2, 5, 10	
E26/E26/E27	110 V/230 V	IP 66	II	1200	10 Years	2, 5, 10	
E26/E26/E27	110 V/230 V	IP 66	II	300	10 Years	0	
E26/E26/E27	110 V/230 V	IP 66	II	500	10 Years	0	
E26/E26/E27	110 V/230 V	IP 66	II	800	10 Years	0	
E26/E26/E27	110 V/230 V	IP 66	II	1200	10 Years	0	
E26/E26/E27	110 V/230 V	IP 66	II	500	10 Years	0	
E26/E26/E27	110 V/230 V	IP 66	II	800	10 Years	0	
E26/E26/E27	110 V/230 V	IP 66	II	1200	10 Years	0	
E26/E26/E27	110 V/230 V	IP 66	II	300	10 Years	0	
E26/E26/E27	110 V/230 V	IP 66	II	500	10 Years	0	
E26/E26/E27	110 V/230 V	IP 66	II	800	10 Years	0	
E26/E26/E27	110 V/230 V	IP 66	II	1200	10 Years	0	
E26/E26/E27	12 V DC	IP 68	II	300	10 Years	10, 20	
E26/E26/E27	12 V DC	IP 68	II	500	10 Years	10, 20	
E26/E26/E27	12 V DC	IP 68	II	800	10 Years	10, 20	
E26/E26/E27	12 V DC	IP 68	II	1200	10 Years	10, 20	
E26/E26/E27	110 V/230 V	IP 66	II	500	10 Years	3, 5, 10	
E26/E26/E27	110 V/230 V	IP 66	II	800	10 Years	3, 5, 10	
E26/E26/E27	110 V/230 V	IP 66	II	1200	10 Years	3, 5, 10	

Moonlight USA

Moonlight USA, Inc
4814 Cape Coral Street
USA – Cape Coral, FL 33904

info@moonlight-inc.com
Phone: +1 239-541-8670

Moonlight Korea

Bon Hyun Koo
#708, 111, Seongsuil-ro, Seongdong-gu,
Seoul, Republic of Korea

bhkoo@moonlight.info
Phone: +82 2 3407 5477
Mobile: +82 10 7103 0597

Moonlight Serbia

DieMMe d.o.o.
Bulevar Kralja Aleksandra 104,
11000 Beograd, Srbija

m.roncevic@diemme.co.rs
Phone: +381-63-8379950